

Reference Manual

DVD 5480 H

**Dual-Channel 12G SDI Video Distribution Amplifier
with 12G Single link <> Quad-link (2SI) High-density connectors**

Revision 1.2 –Dec 2020

This Manual Supports Device Revisions:	
DVD 5480 Firmware Revision	942
Control System GUI Release	8.12.0

Information in this document is subject to change without notice. No part of this document may be reproduced or transmitted in any form or by any means, electronic or mechanical for any purpose, without express written permission of LYNX Technik AG.

LYNX Technik AG may have patents, patent applications, trademarks, copyrights or other intellectual property rights covering the subject matter in this document. Except as expressly written by LYNX Technik AG, the furnishing of this document does not give you any license to patents, trademarks, copyrights or other intellectual property of LYNX Technik AG or any of its affiliates.

LYNX Technik AG
Brunnenweg 3
D 64331 Weiterstadt
Germany
www.lynx-technik.com

Contents

Contents	2
Warranty	4
Regulatory information	5
Europe	5
Declaration of Conformity	5
USA	5
FCC 47 Part 15	5
Getting Started.....	6
Packaging.....	6
ESD Warning.....	6
Preventing ESD Damage.....	6
Caution.....	6
Product Description	7
Key Features	7
Functional Diagram (Complete)	8
Application 1: Distribution Mode.....	9
Application 2: Multiplex Mode.....	10
Application 3: Demultiplex mode.....	11
Module Layout.....	12
Connections	13
High-Density MicroBNC	13
Installation	13
Control System GUI.....	15
Overview	16
flexGUI path highlighting and signal patching.....	16
Single link to Quad-link 2SI Converter	17
Device Event Tab	18
Parameters	18
All Control is through Parameters	20
General GUI functions.....	21
Device Properties	21
Locate.....	21
New Control Window.....	21
Rename	21
Save Settings Now	22
Lock.....	22
Reset Factory Defaults.....	22
Settings Management	22
Specifications	23
Settings and control.....	24

Service25
 Technical Support 25
Contact Information25

Warranty

LYNX Technik AG warrants that the product will be free from defects in materials and workmanship for a period of three (3) years from the date of shipment. If this product proves defective during the warranty period, LYNX Technik AG at its option will either repair the defective product without charge for parts and labor or will provide a replacement in exchange for the defective product.

In order to obtain service under this warranty, the customer must notify LYNX Technik of the defect before the expiration of the warranty period and make suitable arrangements for the performance of service. The customer shall be responsible for packaging and shipping the defective product to the service center designated by LYNX Technik, with shipping charges prepaid. LYNX Technik shall pay for the return of the product to the customer if the shipment is within the country which the LYNX Technik service center is located. The customer shall be responsible for payment of all shipping charges, duties, taxes and any other charges for products returned to any other locations.

This warranty shall not apply to any defect, failure, or damage caused by improper use or improper or inadequate maintenance and care. LYNX Technik shall not be obligated to furnish service under this warranty a) to repair damage resulting from attempts by personnel other than LYNX Technik representatives to install, repair or service the product; b) to repair damage resulting from improper use or connection to incompatible equipment; c) to repair any damage or malfunction caused by the use of non-LYNX Technik AG supplies; or d) to service a product which has been modified or integrated with other products when the effect of such modification or integration increases the time or difficulty servicing the product.

THIS WARRANTY IS GIVEN BY LYNX TECHNIK WITH RESPECT TO THIS PRODUCT IN LIEU OF ANY OTHER WARRANTIES, EXPRESS OR IMPLIED. LYNX TECHNIK AND ITS VENDORS DISCLAIM ANY IMPLIED WARRANTIES OF MERCHANTABILITY OR FITNESS FOR A PARTICULAR PURPOSE. LYNX TECHNIK'S RESPONSIBILITY TO REPAIR AND REPLACE DEFECTIVE PRODUCTS IS THE SOLE AND EXCLUSIVE REMEDY PROVIDED TO THE CUSTOMER FOR BREACH OF THIS WARRANTY. LYNX TECHNIK AND ITS VENDORS WILL NOT BE LIABLE FOR ANY INDIRECT, SPECIAL, INCIDENTAL, OR CONSEQUENTIAL DAMAGES IRRESPECTIVE OF WHETHER LYNX TECHNIK OR THE VENDOR HAS ADVANCE NOTICE OF THE POSSIBILITY OF SUCH DAMAGES.

Regulatory information

Europe

Declaration of Conformity

We	LYNX Technik AG Brunnenweg 3 D-64331 Weiterstadt Germany
<i>Declare under our sole responsibility that the product</i>	
TYPE: DVD 5480-H/HO/TO	
<i>To which this declaration relates is in conformity with the following standards (environments E1-E3):</i>	
EN 55103-1 /2009	
EN 55103-2 /2009	
EN 60950-1 /2006	
<i>Following the provisions of 2014/30/EU and 2006/95/EC directives.</i>	
Weiterstadt, Sept 2019	
<i>Place and date of issue</i>	Legal Signature Stefan Gnann / CEO

USA

FCC 47 Part 15

This device complies with part 15 of the FCC Rules. Operation is subject to the following two conditions: (1) This device may not cause harmful interference, and (2) this device must accept any interference received, including interference that may cause undesired operation.

Note: This equipment has been tested and found to comply with the limits for a Class A digital device, pursuant to the part 15 of the FCC Rules. These limits are designed to provide reasonable protection against harmful interference when the equipment is operated in a commercial environment. This equipment generates, uses, and can radiate radio frequency energy and, if not installed and used in accordance with the instruction manual, may cause harmful interference to radio communications. Operation of this equipment in a residential area is likely to cause harmful interference in which case the user will be required to correct the interference at their own expense.

Getting Started

Most CardModules are installed into the rack frames and system tested in the factory. If this is an upgrade part or service exchange item then the module is supplied in a padded cardboard carton which includes the CardModule, rear connection plate and mounting screws.

Packaging

The shipping carton and packaging materials provide protection for the module during transit. Please retain the shipping cartons in case the subsequent shipping of the product becomes necessary. Do not remove the module from its protective static bag unless observing adequate ESD precautions. Please see below.

ESD Warning



This product is static sensitive. Please use caution and use preventative measures to prevent static discharge that could damage the module.

Preventing ESD Damage

Electrostatic discharge (ESD) damage occurs when electronic assemblies or the components are improperly handled and can result in complete or intermittent failure.

Do not handle the module unless using an ESD-preventative wrist strap and ensure that it makes good skin contact. Connect the strap to any solid grounding source such as any exposed metal on the rack chassis or any other unpainted metal surface.

Caution

Periodically check the resistance value of the antistatic strap. The measurement should be between 1 and 10 MOhms.

Product Description

The DVD 5480 H module is a high-performance state of the art, 12G SDI distribution amplifier with dual 12G Single link <> Quad-link (2SI) conversion on electrical interfaces. This module can be used in various applications depending on user settings:

1. Dual 12G SDI (1 → 5) distribution amplifier or single 12G SDI (1 → 10) distribution amplifier
2. Dual 12G SDI Single link to Quad-link (2SI) converter (Demux)
3. Dual Quad-link 3G SDI (2SI) to 12G SDI Single link Converter (Mux)

DVD 5480 H is ideally suited for demanding high-quality broadcast and professional video applications. Along with six bi-directional 12G SDI high-density microBNC electrical interfaces, the module also provides two dedicated input and four dedicated output electrical interfaces on microBNCs as well.

Designed for the use in SERIES 5000, DVD 5480 H is part of CardModules, which offers high quality, modularity and flexibility in a small form factor ideal for applications where space is at a premium. Like other 5000 series CardModules, this module is fully integrated into LYNX APPolo Control system which provides remote control, status monitoring and error reporting for the module

Key Features

- Supports six bidirectional electrical inputs/outputs with an additional two inputs and four output electrical interfaces.
- Several applications:
 - Dual 12G SDI single link input signal can be demultiplexed to quad-link (2SI) independently
 - Dual Quad-link 3G SDI (2SI) signals can be multiplexed to 12G SDI Single link independently
 - One 12G SDI signal can be distributed to ten electrical outputs
 - User-selectable mixture of operation modes for multiple applications at the same time.
- Incoming and outgoing 12G SDI signals are re-clocked.
- Input presence detection with LED indication
- Microprocessor controlled with internal flash RAM for storing configuration
- Remote control, status monitoring and error reporting when used with LYNX Appolo Control System
- Hot-swappable

Functional Diagram (Complete)

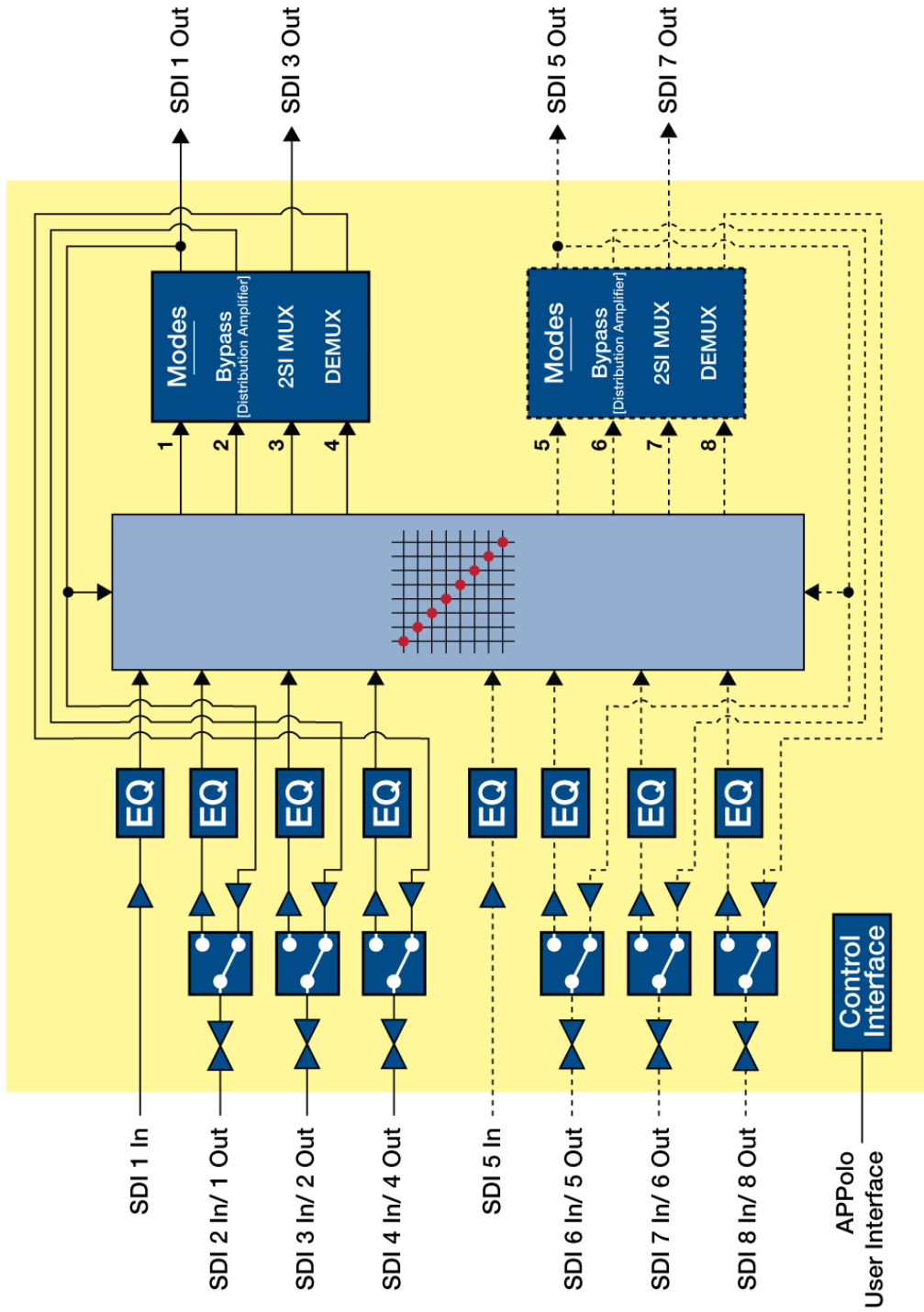

Application 1: Distribution Mode

In this mode, dual 12G SDI signals are distributed to five outputs each (1 → 5) or a single 12G SDI input is distributed to 10 outputs (1 → 10). The output path can be manually selected by the user via LYNX Appolo User interface.

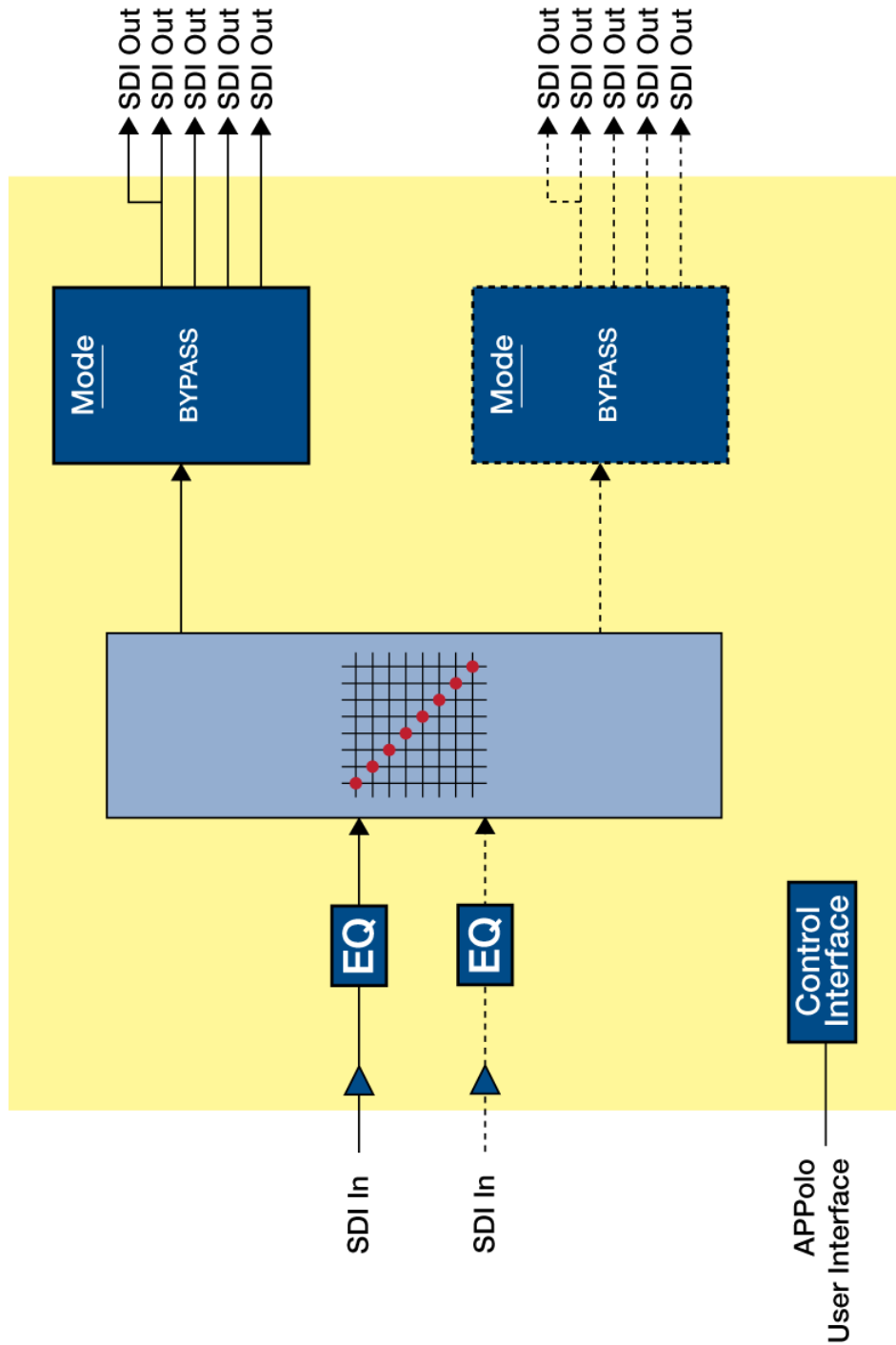

Application 2: Multiplex Mode.

In this mode, dual quad-link 3G SDI (2SI) signals are multiplexed in to two 12G SDI single link electrical outputs. Each of the output 12G SDI single link is also distributed on to two other 12G SDI electrical interfaces thereby providing two 12G SDI single link output for each quad-link 2SI to single link conversion

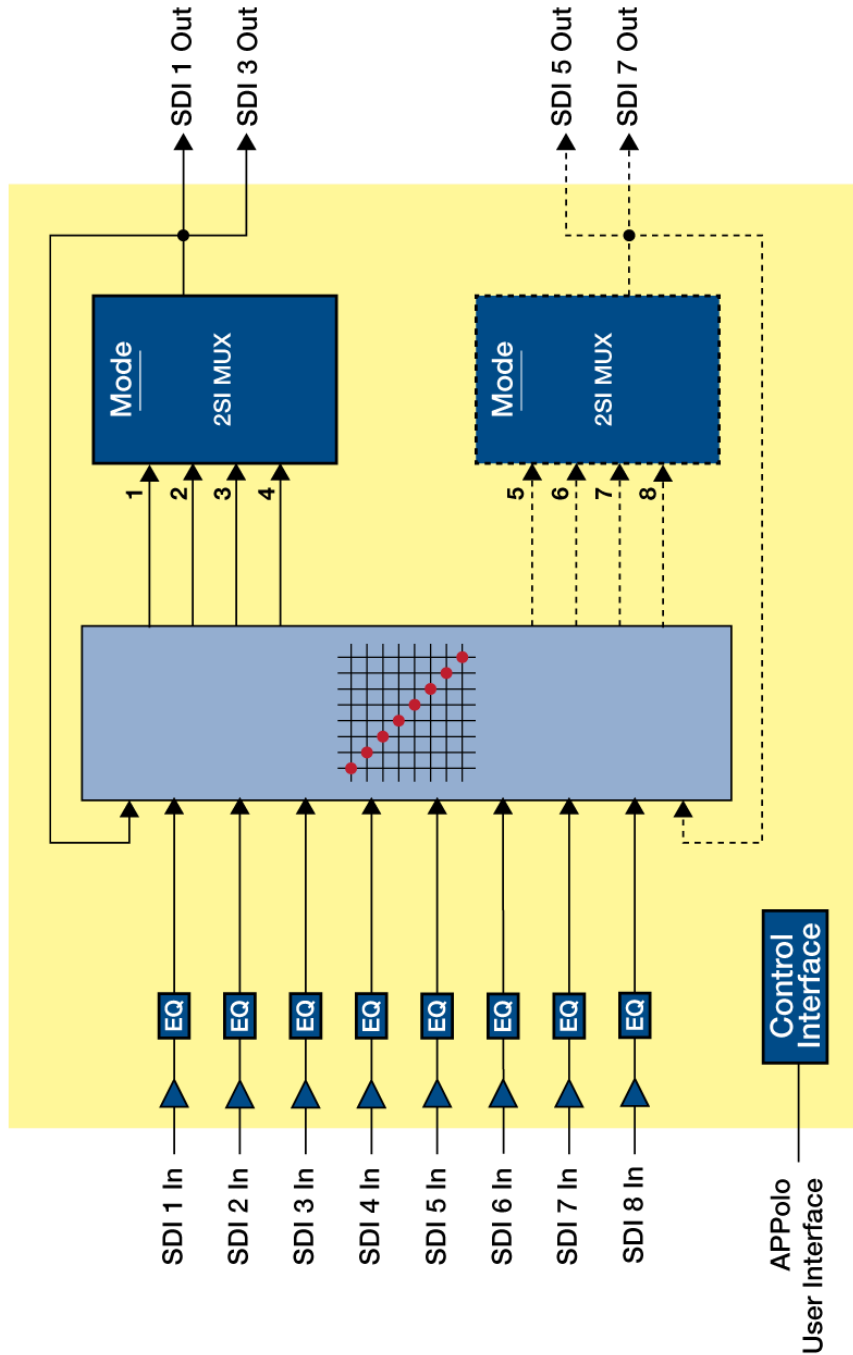

Application 3: Demultiplex mode

In this mode, dual 12G SDI single link are demultiplexed into dual quad-link (2SI) electrical outputs

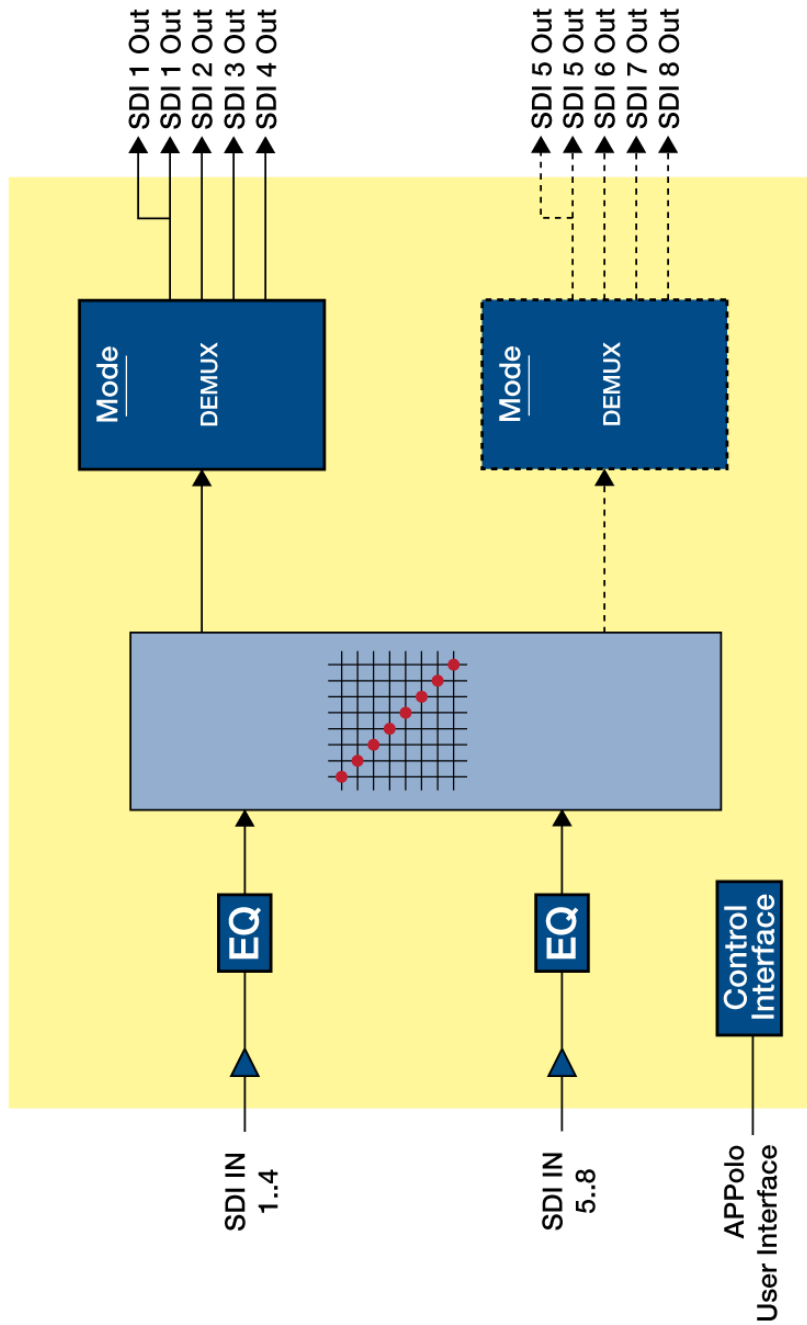

Module Layout

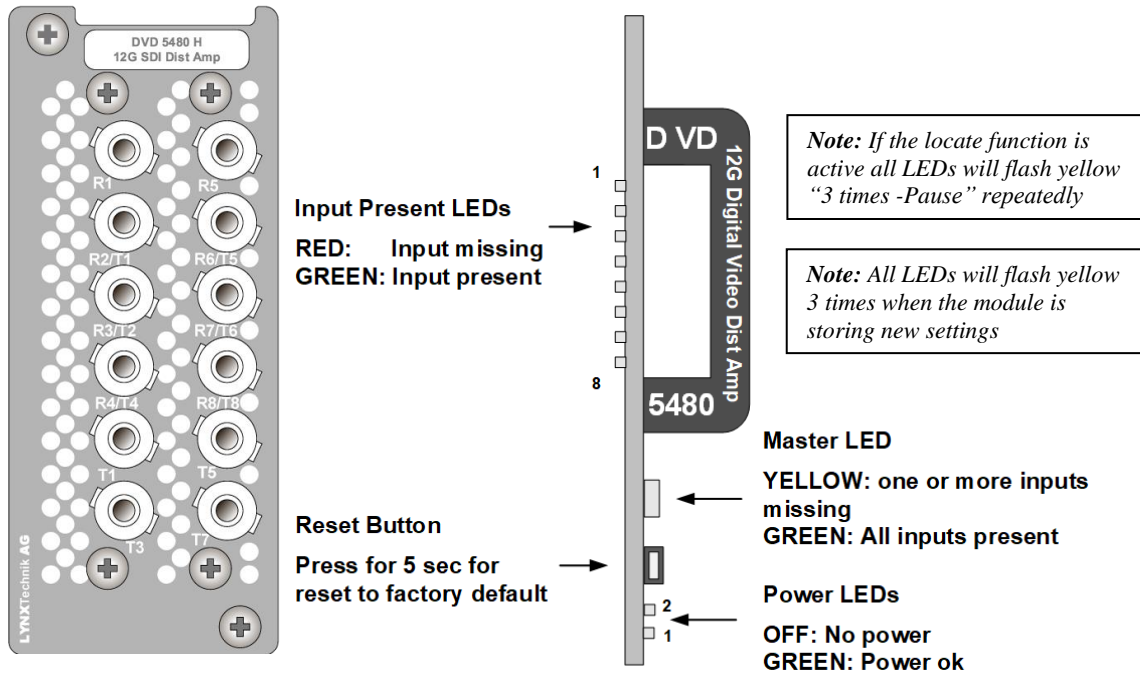

Termination Panel

Module Front

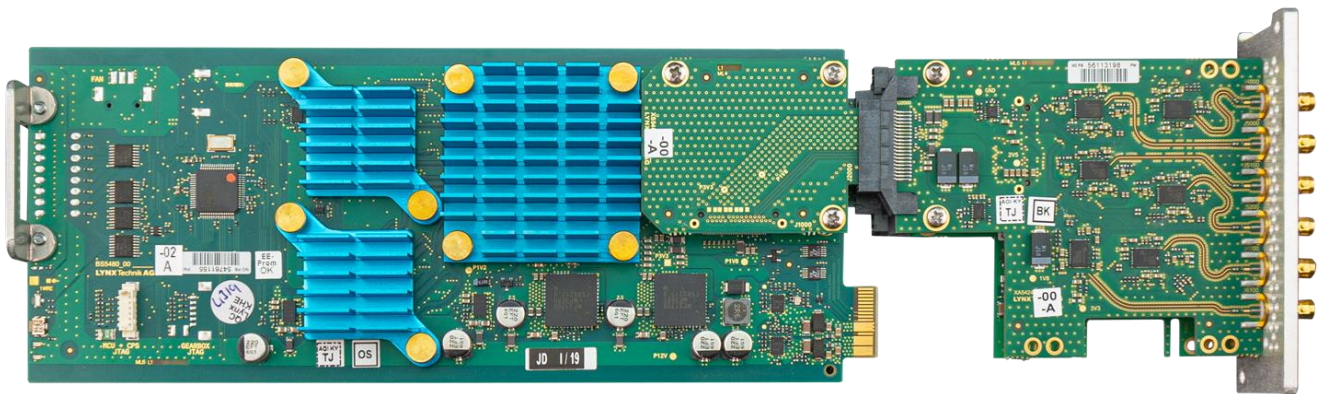

Card Module (Card + Termination Panel)

Connections

High-Density MicroBNC

There are 12 High-Density Micro BNCs on the DVD 5480 H card. Six HD Micro BNCs are bi-directional electrical interfaces and can be set as input or output for 12G SDI signals. The module also provides two dedicated 12G SDI inputs and four dedicated 12G SDI outputs on high-density Micro BNCs. All the Micro BNC connectors are optimized for 12G SDI / UHD Broadcast applications.

Installation

If this module was supplied as part of a system, it is already installed in the rack enclosure. If the module was supplied as a field upgrade, please follow the installation procedure below.



NOTE Observe static precautions when handling the card.
Please see ESD warnings on Page 6.

Each Card Module is supplied with a rear connection panel and mounting screws. Please follow the procedure below for the installation of the card module into the Series 5000 Card Frame.

NOTE. 1. This module should be installed in the RFR 5018 RackFrame with a Fan Front Cover to ensure sufficient airflow into the RackFrame.

2. A maximum number of 8 DVD 5480 H modules can be installed in the RFR 5018 rack frame. The two slots next to the power supplies cannot be used for this module due to Fan unit installed at the bottom of Slots 1 & 2, as shown below:

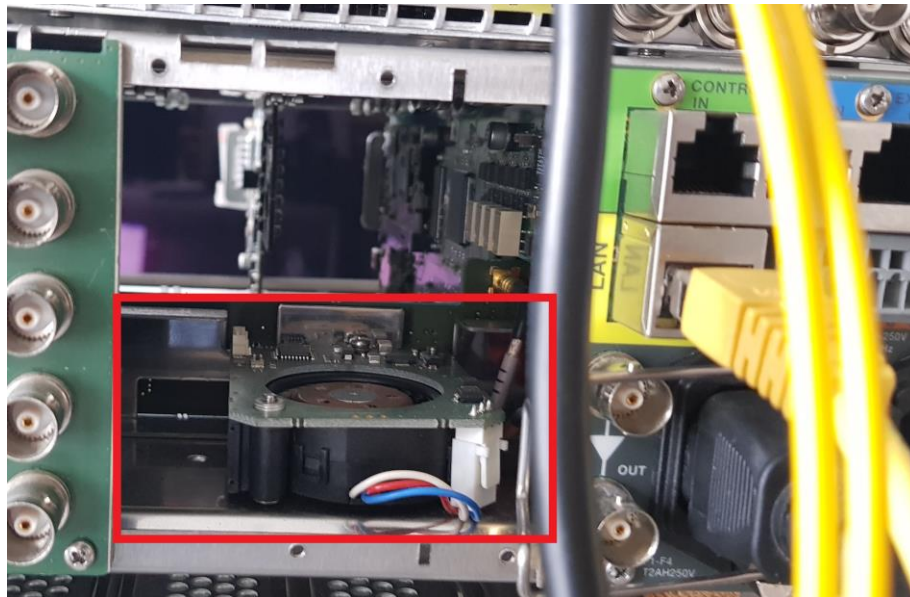

All modules except DVD 5480 H and DVD 5480 HO/TO can be installed on slot 1 & 2 due to their smaller size backplanes.

We recommend to power the RackFrame down before installing any additional modules into an existing RackFrame.

1. Select a free slot space in the card frame where the CardModule will be located.
2. Remove the blank connection panels from the rear of the rack (if fitted)
3. Install the rear connection panel using the screws supplied. Do not tighten the screws fully
4. Slide the card module into the card frame and carefully check the CardModule connects to the rear connection plate. The card should fit easily and should not require excessive force to insert - if you feel any resistance, there could be something wrong with the rear connection panel location. **Do not** try and force the connection this may damage the connectors. Remove the rear connection panel and check alignment with the CardModule.
5. Insert and remove the CardModule a few times to ensure correct alignment and then tighten the two screws to secure the rear connection plate.
6. Power up the rack and check the module LEDs and matrix display illuminates. Check the control system device tree to confirm the module is connected properly. *(It may take a few seconds for the control system to "discover" the new module)*

Control System GUI

All LYNX CardModules support a computer interface that allows setting the module parameters using a simple GUI interface. Access to all standard features *and in some cases* extended features is possible using this interface.

NOTE: Any settings made using the control system overrides any local settings made on the module. All settings are stored in internal flash ram and will survive power cycles and long term storage.

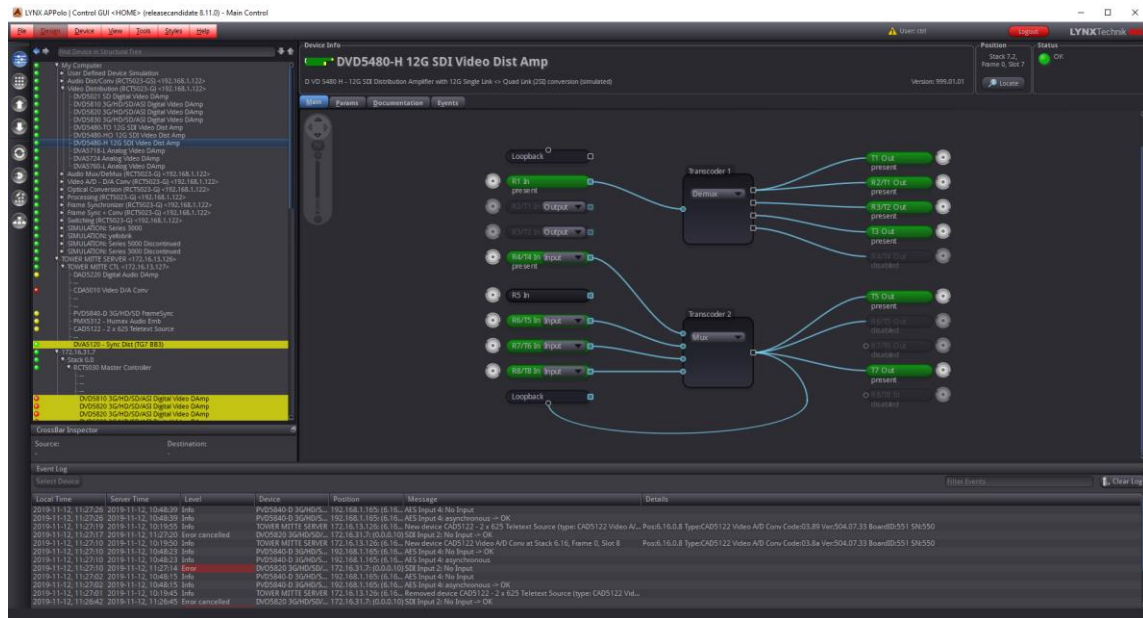

The picture above shows the complete module GUI. The “Device Info” area across the top contains information about the module including name and firmware revision. The “Position” area displays the module’s position and physical location. This is useful if the device is installed as part of a larger installation.

NOTE: The Locate button (in the “Position” area) is a useful tool to quickly identify a module in larger systems. Activating “Locate” will flash the module’s alarm LED in yellow color. (this does not affect the module’s operation in any way). This function will be stopped automatically (timeout).

The “Error Log” at the bottom of the screen displays an individual timestamped message for any error or warning condition in the system. The same information can always be found in the APPolo Control System’s textual logfiles.

The primary GUI screens and functions are described in the following sections.

Overview

The MAIN Tab (see picture below) visualizes the module's functionality. *Selections are made using onscreen drop-down selections.* The screen can be zoomed in/out using the mouse-wheel or the navigation tool in the top left corner of the screen.

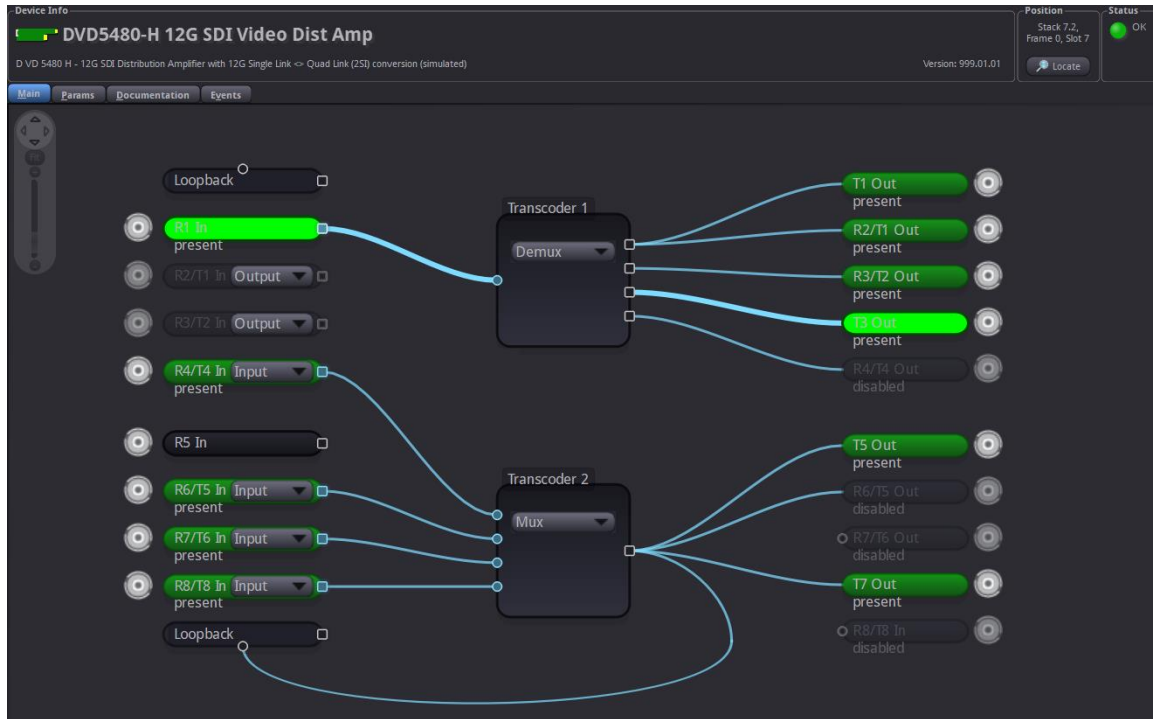

flexGUI path highlighting and signal patching

The flexGUI shows all current signal connections as lines (i.e. it does not show any signal lines that are unused dead ends). Hovering the mouse pointer over any such signal line will highlight the complete signal path that leads to this point. This illustrates clearly where the particular signal is coming from. Similarly, the downstream path is highlighted to show where this signal is going to.

To re-connect an input signal (change the routing) you can think of a signal line as a patch-cable that has to be connected to the desired source. Hovering the mouse-pointer over a flexible signal will show a handle. Grab the handle (click-and-hold) with the left mouse button and drag-and-drop it to the new desired source.

Single link to Quad-link 2SI Converter

The DVD 5480 H module has two Single links <> Quad-link 2SI Converters. These converters can be set to “Mux”, “Demux” or “Bypass”.

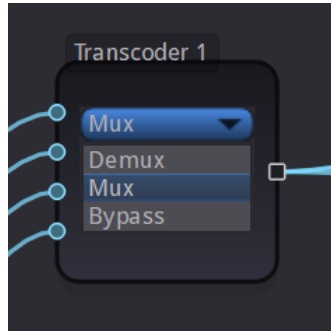

In “Mux” mode the connected inputs (Quad-link 3G 2SI) will be multiplexed to a single 12G SDI signal.
(2SI = Two Sample Interleave) signal

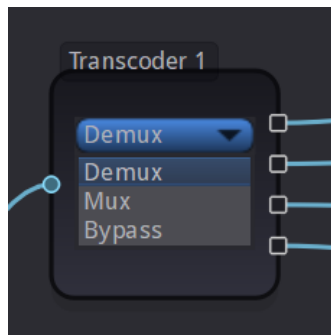

In “Demux” mode the connected input will be demultiplexed to a quad 3G SDI (2SI = Two Sample Interleave) signal

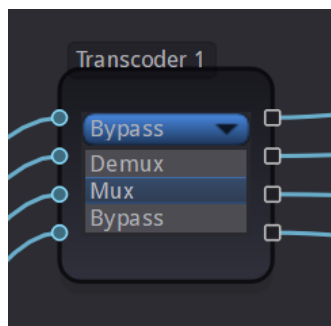

In “Bypass” Mode the connected inputs will be transparently passed to the outputs

Device Event Tab

The Events Tab is where the module alarming and error notifications are configured for the module. Any of the possible Events that the device can generate can be disabled here, which will declare such Events as irrelevant. Once an Event has been disabled in this Events-Tab, the Event will not be reported to the APPolo control system, it will not be logged in the logfiles, and it will not even influence the local LEDs of the device.

For all Events that are enabled (which is the default): as soon as the monitored condition becomes critical (e.g. input signal lost), the Event becomes ACTIVE. This change of state generates a message in the APPolo Control System. This message is stored in the APPolo Server logfile. Later, when the condition is not critical anymore (e.g. input signal present again), another message is logged in the APPolo Event System, and also saved in the logfile.

Additionally, these messages can be displayed in the APPolo GUI's Event Log (bottom part of the APPolo GUI, enabled from the "View" menu). This can, however, be disabled by removing the checkboxes from the "Log in GUI" columns (separately for "Event becomes Active" and "Event not active anymore" messages).

Similarly, an SNMP trap can be generated from the APPolo Server for any message in the APPolo Event System. Refer to the LYNX Remote Control Guide for more information on SNMP (available from <https://www.lynx-technik.com/products/appolo-control/>).

Parameters

The "Params" tab lists all available control parameters of the complete device. Every switch and function in any other part of the GUI is actually just a graphical control of a parameter listed on this page. There are, however, a number of parameters for more detailed control that are only accessible in this list of parameters on the "Params" tab.

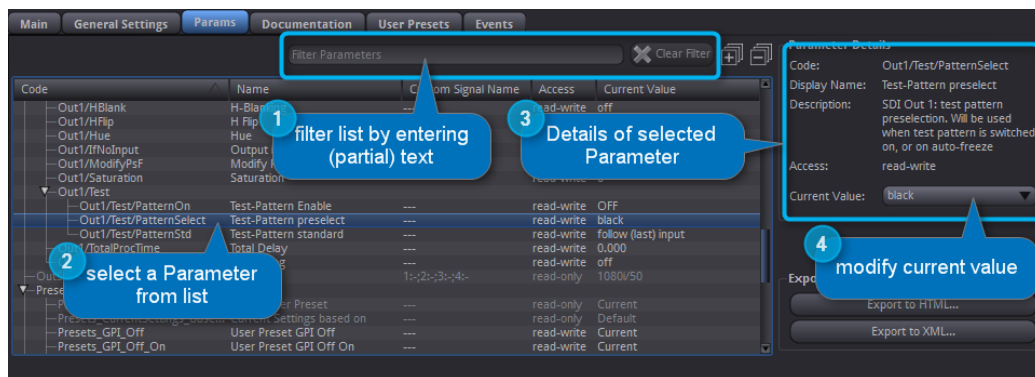

All parameters are defined by the following aspects:

- **Code:** This is a unique code to identify the parameter. The Code can contain the slash-character '/', to provide some structure to the total collection of parameters. The Parameter Code is always to be specified as the complete text string (i.e. including all slashes).
- **Name:** a human-readable short parameter name, which is used as the default text label in most parts of the GUI, as well as in any CustomControl Panel.

- **Access:** read-write or read-only accessibility. Note that for some parameters, the accessibility status may potentially change, depending on the current value of other parameters. E.g. the value of parameter A might be controlled automatically by default, so the accessibility of A will be displayed as “read-only”. But a boolean parameter B might be provided to switch off the automatic behavior. So when parameter B is set to MANUAL, then parameter A would dynamically change to “read-write”.
- **Current Value:** This is the current value of the parameter. If Accessibility is “read-write” (see above), then the Current Value can be modified.
- **Description:** a textual explanation of the behavior of the individual parameter.

You can use the “Filter” function (located above the actual list of parameters) to show only a subset of the complete list, based on textual filtering. The filter will actually search in any part of the parameter definition, including the parameter code, the textual description, and even the Current Value.

NOTE: In theory, it would be possible to manage and monitor the complete functionality of the DVD 5480 H by accessing the relevant parameters on this tab only. All the other tabs in the GUI are only provided to provide better explanations and overviews.

All Control is through Parameters

As stated above, the complete behavior of any LYNX Device can be controlled and monitored through the parameters listed on the “Params” tab. All other parts of the LYNX APPolo Control System use these Parameter to take access to any aspect of the Device.

- The LYNX CustomControl feature connects the individual elements of a custom-made Design to real device parameters by their Code.
See <https://appolo.lynx-technik.com/> -> CustomControl for details.
- The LYNX AutoControl automation rules access the individual Parameters (for both Conditions and Actions) by their Code.
See <https://appolo.lynx-technik.com/> -> AutoControl for details.
- The LYNX RemoteIF API addresses individual Parameters by Code.
See <https://appolo.lynx-technik.com/> -> RemoteControl for details.
- The LYNX SNMP Control provides one OID (numerical address in the MIB) per individual Parameters. The exact mapping of Parameter Code to OID is provided in the MIB files. See <https://appolo.lynx-technik.com/> -> RemoteControl for details.

Finding the Parameter Code name for a given Parameter in the graphical GUI is made easy by clicking the Right-Mouse-Button onto the graphical control anywhere in the GUI and then selecting the “Parameter Details” option (see picture below).

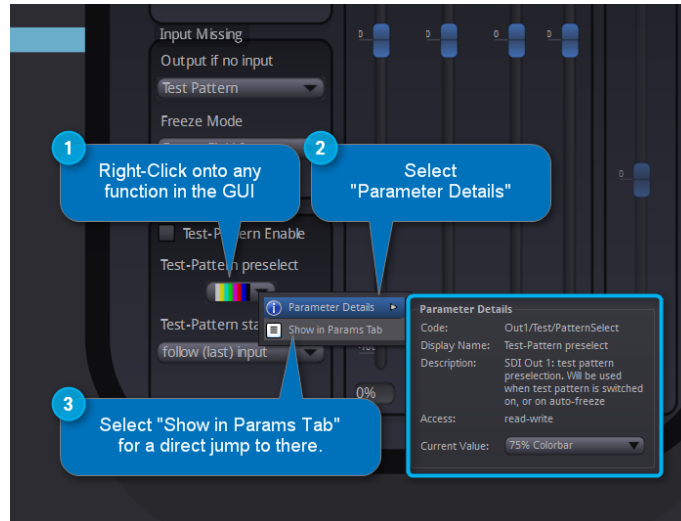

General GUI functions

There are a number of functions and commands of the LYNX APPolo Control System which are common for all LYNX devices.

A click with the Right-Mouse-Button on any module in the DeviceTree will generate the same menu that is available from the “Device” menu. This menu provides the following options:

Device Properties

The first entry in the Device menu opens a sub-menu page which shows device-specific properties about the selected module.

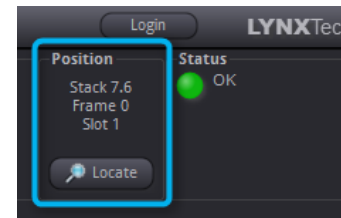
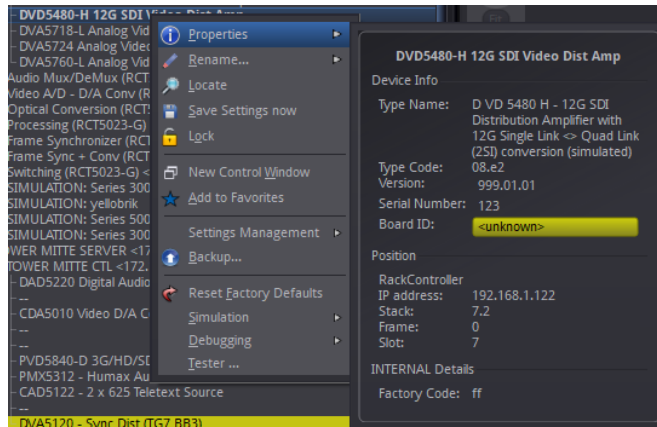
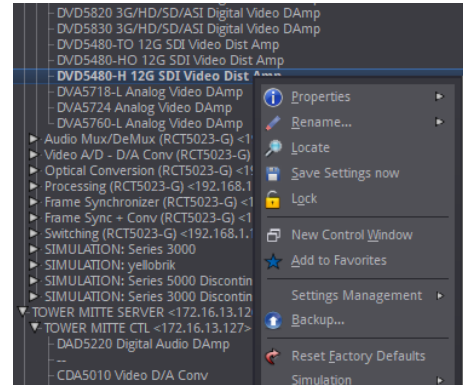

Locate

This function is useful if you need to physically locate a module in a larger system quickly (for removal or maintenance purposes) When Locate selected this will flash the module alarm LED yellow. This function does not impact normal module operation and will timeout after a short time period.

New Control Window

Selecting this option will open up a separate GUI window showing just the controls for the current module. This new window can be used to arrange multiple devices on your desktop or similar.

Rename

It is possible to rename individual items (RackFrames and individual devices) in the APPolo Device Tree. The default name of a device is the LYNX product name. This name can be modified at any time. The original (default) name can be restored by simply removing the custom name from that renaming field (save this as an empty name).

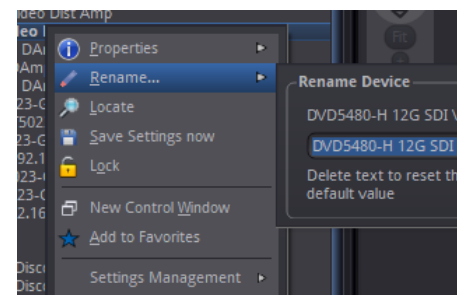

NOTE: The names are stored inside the flash memory of a LYNX server (if installed) or the hard disk of the connected Computer respectively.

Save Settings Now

Any modification to any parameter of a device is immediately propagated from the APPolo GUI to the hardware device (card) and made effective. The current settings are saved in a local FlashRAM of the device so that the device will continue to work in the exact same configuration after a power-cycle. But in order to reduce the number of write-operations on the physical FlashRAM, the actual storage of a modified configuration into the FlashRAM is only executed approximately 10 seconds after the last change to any setting in the whole card. This operation is visualized on the board by all local LEDs flashing three times in yellow color.

Consequently, if you remove a card from a system BEFORE the last changes have been saved to FlashRAM, those last changes will not be available on the next power-up.

The “Save Settings Now” operation in this menu can force the current configuration of this device to be stored to the local FlashRAM now. If in doubt, this function should be executed before a device is physically removed from the system, or before electrical power is shut down.

Lock

Selecting this will lock the device to prevent any accidental changes being made to the module’s settings. The module status can be seen but all the controls will be grayed out. To unlock simply deselect the lock control from the menu.

Reset Factory Defaults

Executing this function will reset all the individual settings of all parameters of the device back to the predefined state that has been defined by the manufacturer. All custom adaptations will be lost. This operation cannot be undone.

Settings Management

The complete current configuration of one device can be copied into an internal “clipboard” and pasted onto a different device of the same type. Alternatively, the complete current configuration can be stored in a local file (as a very simple single-device backup).

Specifications

Video Input	
Signal Type	SMPTE 292M, 424M, 2082-1
No. of Inputs	6 x bi-directional 12G-SDI BNC, 2x 12G-SDI BNC
Connector	microBNC
Input Impedence	75 Ohms
Return Loss	>4dB up to 12 Gbit/s
Cable Length	190m @ 1.5 GBps, 130m @ 3 Gbps, 55m @12 Gbps
Video Output	
Signal Type	SMPTE 292M, 424M, 2082-1
No. of Inputs	6 x bi-directional 12G-SDI BNC, 4x 12G-SDI BNC
Connector	microBNC
Return Loss	>4dB up to 12 Gbit/s
Performance	
2SI Mux/Demux	Two Converters for 12G SDI Single link to Quad-link (2SI) Conversion or Quad-link (2SI) to 12G SDI Single link can be activated
Electrical	
Operating Voltage	+ 12 VDC
Power Consumption	19W
Safety	IEC 60950 / EN 60950 / VDE 0805
Mechanical	
Size	283mm x 78mm
Weight	CardModule 120g, connector plate 100g
Ambient*	
Temperature	5°C – 40°C Maintaining Specifications
Humidity	90% maximum, non-condensing
*It is strongly recommended to operate DVD 5480 H in a Series 5000 Rack with front panel fans and to keep the front panel closed during the operation. This will protect DVD 5480 H from overheating and will avoid any signaling error due to the high temperature of the card.	

Settings and control

Control	
Remote control	Full remote control and status monitoring supported with the APPolo control system. Supported version: APPolo 8.11.0 or above
On Board Indicators / LEDs	
Input Port status	8 x LED
Master status	1 x LED
Power status	1 x LED
Supported Video Standards	
Bits / color	10 Bit / 4:2:2 (Y,Cr,Cb)
Formats: 1.5 Gbit	720p / 60 / 59.94 / 50 / 30 / 29.97 / 25 / 24 / 23.98 Hz 1080i / 60 / 59.94 / 50 Hz 1080p / 30 / 29.97 / 25 / 24 / 23.98 Hz 1080psF / 25 / 24 / 23.98 Hz
Formats: 3.0 Gbit	1080p / 60 / 59.94 / 50 Hz (Level A)
Formats: 12.0 Gbit	2160p / 60 / 59.94 / 50 Hz

Service

Technical Support

If you are experiencing problems, or have questions please contact your local distributor, authorized dealer or reseller for more details. Please do not return products to LYNX without an RMA.

For FAQs and Technical support visit <http://support.lynx-technik.com>

General product information is available on <http://www.lynx-technik.com>

Contact Information

Please contact your local distributor; this is your local and fastest method for obtaining support and sales information.

On the LYNX homepage, you will find a support section including downloads and entry to the LYNX ticket system. A knowledge base provides information about common questions there.

LYNX Technik can be contacted directly using the information below.

Address	LYNX Technik AG Brunnenweg 3 D-64331 Weiterstadt Germany
Website	www.lynx-technik.com
E-Mail	info@lynx-technik.com

LYNX Technik manufactures a complete range of high-quality modular products for broadcast and Professional markets, please contact your local representative or visit our web site for more product information.

LYNXTechnik **AG**
Broadcast Television Equipment